

COMPLETE BIO-LABELING SOLUTIONS



V ČR a SR nakupujte na:
www.biologicals.cz/e-shop
orders@biologicals.cz
Tel: +420-274776731



Biologicals

-196°C

WRAP-AROUND LABELS NOW AVAILABLE IN **COLOR!**





COLOR CODES



LASER LABELS

- ● CRYOGENIC LASER LABELS P.4
- ● A4 LASER LABEL TEMPLATES P.5
- ● COLOR DOTS & RECTANGLES P.6

ROLL FORMAT LABELS

- ● DEEP-FREEZE BARCODE LABELS P.8
- ● FROZEN CONTAINER BARCODE LABELS P.11
- ● XYLENE & SOLVENT RESISTANT BARCODE LABELS P.12
- ● CRYOGENIC WRAP-AROUND BARCODE LABELS P.14
- ● CRYOGENIC STRAW-TAG™ LABELS P.15
- ● CRYOGENIC LABELS FOR METAL RACKS P.16
- ● CALIBRATION AND ANIMAL CAGE LABELS P.17
- ● WARNING LABELS P.18
- ● TAMPER-PROOF LABELS P.19
- ● DIRECT THERMAL DYMO-COMPATIBLE LABELS P.20

LAB SUPPLIES

- ● LAB SUPPLIES P.21

TAPES

- ● CRYO-TAPE™ P.22
- ● CryoSTUCK™ FOR FROZEN CONTAINERS P.22
- ● TAMPER-EVIDENT CRYO-TAPE™ P.22
- ● CRYO-LAMINATE™ P.23
- ● CRYO-TAPE™ FOR METAL RACKS P.23
- ● COLOR LAB-TAPE™ P.23

CRYO MARKERS

- ● ALCOHOL RESISTANT SCIENCE-MARKER™ P.24
- ● DUAL POINT CRYO-MARKER™ P.24
- ● MICRO-TIP CRYO-MARKER™ P.24
- ● BIG-TIP CRYO-WAXI™ MARKER P.24

PRINT SOLUTIONS

- ● PRINTING KITS P.25
- ● PRINTERS P.26
- ● SOFTWARE P.26
- ● SCANNERS P.27
- ● RIBBONS P.28

CUSTOM LABELS

- ● CUSTOM MANUFACTURING P.30

“At your service since 1999”

Cryogenic Laser LABELS

A4 Format



Cryo LazrTAG™

Temperature range from -196°C to +120°C

Patented

Plastic waterproof labels for long-term cryogenic, deep-freeze and conventional storage in biomedical research and clinical laboratories. Resistant to storage in liquid phase and vapor phase liquid nitrogen and harsh deep-freeze environments, boiling water and autoclaving. Cryo labels accept desktop laser printing and permanent marker. Easy to format. Microsoft Word templates available on request at info@biologicals.cz.

RECTANGLES / A4 SHEETS		PERMANENT ADHESIVE					
Item #	mm (W x H)	Inches (W x H)	Individual Color		Assorted Colors (A)		Color Selection
			Labels/PK	Cena CZK / PK	Labels/PK	Cena CZK / PK	
A4CL-12T1	24 x 13	0.94" x 0.5"	2,560	1986	-	-	<input type="radio"/> WH
A4CL-36T1	28 x 25.4	1.5" x 1"	880	1986	-	-	<input type="radio"/> WH
A4CL-9T1	31 x 22	1.22" x 0.866"	1,152	1986	-	-	<input type="radio"/> WH
A4CL-23T1	32.5 x 12.7	1.28" x 0.5"	2,016	1986	1,764	1820	<input type="radio"/> WH
A4CL-6T1	36 x 14	1.42" x 0.55"	1,600	1986	-	-	<input type="radio"/> WH
A4CL-8T1	45 x 20	1.77" x 0.78"	896	1986	-	-	<input type="radio"/> WH
A4CL-3T1	63.5 x 25.4	2.5" x 1"	528	1986	-	-	<input type="radio"/> WH
A4CL-11T1	64 x 7	2.52" x 0.275"	1,920	1986	-	-	<input type="radio"/> WH
A4CL-28T1	215.9 x 298.45	8.5" x 11.75"	16	1986	-	-	<input type="radio"/> WH

CIRCLES / A4 SHEETS		PERMANENT ADHESIVE					
Item #	mm (Diameter)	Inches (Diameter)	Individual Color		Assorted Colors (A)		Color Selection
			Labels/PK	Cena CZK / PK	Labels/PK	Cena CZK / PK	
*A4CL-48T1	11	0.433"	2,560	1986	4,620	1820	<input type="radio"/> WH

* Circle labels for vial tops are not recommended for liquid nitrogen use



Veškeré informace na www.biologicals.cz a www.biologicals.cz/e-shop

Biologicals s.r.o. Objednávejte na orders@biologicals.cz a www.biologicals.cz/e-shop; Tel: +420-274776731; FAX: +420-274773997; Mobil: +420-608315488

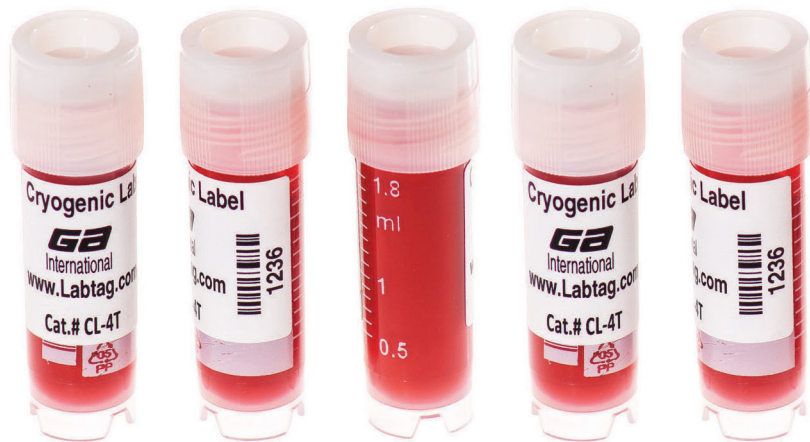

LOOKING FOR CUSTOM LABELS?
 Informujte se na
 +420-274776731 / info@biologicals.cz
 www.biologicals.cz a www.biologicals.cz/e-shop

WRAP-AROUND / A4 SHEETS		PERMANENT ADHESIVE					
Item #	mm (Diameter)	Inches (Diameter)	Individual Color		Assorted Colors (A)		Color Selection
			Labels/PK	Cena CZK / PK	Labels/PK	Cena CZK / PK	<input type="radio"/> WH <input type="radio"/> GA <input type="radio"/> PI <input type="radio"/> BL <input type="radio"/> OR <input type="radio"/> YE <input type="radio"/> SI <input type="radio"/> A
A4DFSL-65	25.4 x 15.24 + 40.64	1" x 0.6" + 1.6"	2,160	3780	-	-	<input type="radio"/>



Temperature range from -196°C to +120°C

A4 TEMPLATES

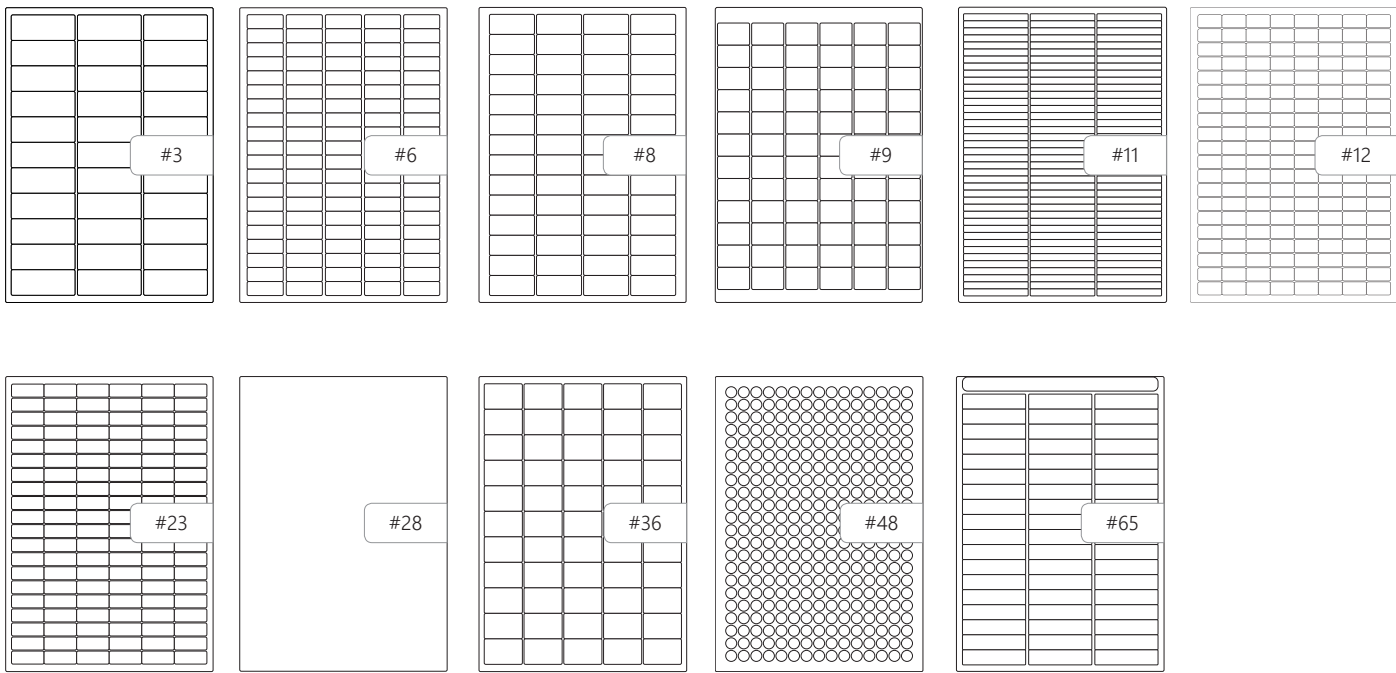

LABELS

COLOR DOTS & RECTANGLES



Lab-TAG™ Labels Temperature range from -80°C to +110°C

Ideal for identification of vials, plastic bags and other containers for long-term storage and color coding in deep-freeze and harsh laboratory environments. Easy to write on with permanent markers – **Recommended MP-1, F-1 and SM-1 markers** (See P.24)

Real size labels

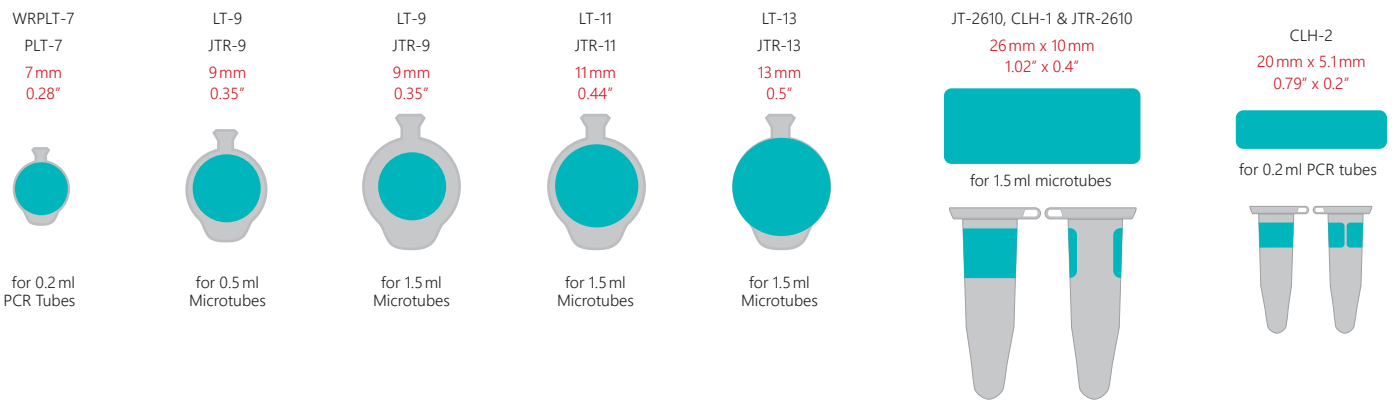

102mm x 152mm SHEETS

Item #	mm	Inches	Description	Individual Color		Assorted Colors (A)		Color Legend																																	
				Labels/PK	Cena CZK/PK	Labels/PK	Cena/PK	WH	SI	BE	YE	LE	GA	MT	PI	LA	BL	OR	BR	RE	VI	GS	A																		
WRPLT-7	7	0.28"	Writable	2400	1727	2,400	1727	○	○	○	○	○	○	○	○	○	○	○	○	○	○	○	○	○	○	○	○	○	○	○	○	○	○								
PLT-7	7	0.28"	Printable	2400	1727	2,400	1727	○	○	○	○	○	○	○	○	○	○	○	○	○	○	○	○	○	○	○	○	○	○	○	○	○	○	○	○						
LT-9	9	0.35"	Writable	1560	1399	1,560	1399	○	○	○	○	○	○	○	○	○	○	○	○	○	○	○	○	○	○	○	○	○	○	○	○	○	○	○	○						
*LT-9X8	9	0.35"	Multi-color Sheet Writable (8 colors)	-	-	520	966	○	○	○	○	○	○	○	○	○	○	○	○	○	○	○	○	○	○	○	○	○	○	○	○	○	○	○	○						
LT-11	11	0.44"	Writable	1386	1399	1,155	1399	○	○	○	○	○	○	○	○	○	○	○	○	○	○	○	○	○	○	○	○	○	○	○	○	○	○	○	○	○					
*LT-11X7	11	0.44"	Multi-color Sheet Writable (7 colors)	-	-	462	966	○	○	○	○	○	○	○	○	○	○	○	○	○	○	○	○	○	○	○	○	○	○	○	○	○	○	○	○	○	○				
LT-13	13	0.5"	Writable	1260	1399	900	1256	○	○	○	○	○	○	○	○	○	○	○	○	○	○	○	○	○	○	○	○	○	○	○	○	○	○	○	○	○	○	○			
CLH-2	20 x 5.1	0.79" x 0.2"	Printable	2436	1629	1,740	1329	○	○	○	○	○	○	○	○	○	○	○	○	○	○	○	○	○	○	○	○	○	○	○	○	○	○	○	○	○	○	○	○		
**JT-2610	26 x 10	1.02" x 0.4"	Writable	1260	1629	1260	1629	○	○	○	○	○	○	○	○	○	○	○	○	○	○	○	○	○	○	○	○	○	○	○	○	○	○	○	○	○	○	○	○	○	
CLH-1	26 x 10	1.02" x 0.4"	Printable	1260	1629	1260	1629	○	○	○	○	○	○	○	○	○	○	○	○	○	○	○	○	○	○	○	○	○	○	○	○	○	○	○	○	○	○	○	○	○	○

* LTR-9X8 & LTR-11X7 come as a multicolor sheet

** JT-2610: For liquid nitrogen storage at -196°C



Multi-Color Cryo Dots

More Colors, Best Performance!



Lab-TAG™ Labels Temperature range from -80°C to +110°C



ROLL FORMAT / 25.4mm CORE IN A DISPENSER BOX

Item #	mm	Inches	Description	Labels/PK	Cena	<input type="radio"/> WH <input type="radio"/> SI <input type="radio"/> BE <input type="radio"/> YE <input type="radio"/> LE <input type="radio"/> GA <input type="radio"/> MT <input type="radio"/> PI <input type="radio"/> LA <input type="radio"/> BL <input type="radio"/> OR <input type="radio"/> BR <input type="radio"/> RE <input type="radio"/> VI <input type="radio"/> GS
JTR-9	9mm Dia.	0.35" Dia.	Roll of individual colors	1,100	1239	<input type="radio"/> WH <input type="radio"/> SI <input type="radio"/> BE <input type="radio"/> YE <input type="radio"/> LE <input type="radio"/> GA <input type="radio"/> MT <input type="radio"/> PI <input type="radio"/> LA <input type="radio"/> BL <input type="radio"/> OR <input type="radio"/> BR <input type="radio"/> RE <input type="radio"/> VI <input type="radio"/> GS
LTR-9X8A	9 mm Dia.	0.35" Dia.	Multi-color roll (8 colors)	5,200	3304	<input type="radio"/> WH <input type="radio"/> SI <input type="radio"/> BE <input type="radio"/> YE <input type="radio"/> LE <input type="radio"/> GA <input type="radio"/> MT <input type="radio"/> PI <input type="radio"/> LA <input type="radio"/> BL <input type="radio"/> OR <input type="radio"/> BR <input type="radio"/> RE <input type="radio"/> VI <input type="radio"/> GS
LTR-11X7A	11 mm Dia.	0.44" Dia.	Multi-color roll (7 colors)	5,200	3304	<input type="radio"/> WH <input type="radio"/> SI <input type="radio"/> BE <input type="radio"/> YE <input type="radio"/> LE <input type="radio"/> GA <input type="radio"/> MT <input type="radio"/> PI <input type="radio"/> LA <input type="radio"/> BL <input type="radio"/> OR <input type="radio"/> BR <input type="radio"/> RE <input type="radio"/> VI <input type="radio"/> GS
JTR-11	11mm Dia.	0.44" Dia.	Roll of individual colors	1,100	1239	<input type="radio"/> WH <input type="radio"/> SI <input type="radio"/> BE <input type="radio"/> YE <input type="radio"/> LE <input type="radio"/> GA <input type="radio"/> MT <input type="radio"/> PI <input type="radio"/> LA <input type="radio"/> BL <input type="radio"/> OR <input type="radio"/> BR <input type="radio"/> RE <input type="radio"/> VI <input type="radio"/> GS
JTR-13	13 mm Dia.	0.5" Dia.	Roll of individual colors	1,100	1239	<input type="radio"/> WH <input type="radio"/> SI <input type="radio"/> BE <input type="radio"/> YE <input type="radio"/> LE <input type="radio"/> GA <input type="radio"/> MT <input type="radio"/> PI <input type="radio"/> LA <input type="radio"/> BL <input type="radio"/> OR <input type="radio"/> BR <input type="radio"/> RE <input type="radio"/> VI <input type="radio"/> GS
*JTR-2610	26 mm x 10 mm	1.02" x 0.4"	Roll of individual colors	1,100	1239	<input type="radio"/> WH <input type="radio"/> SI <input type="radio"/> BE <input type="radio"/> YE <input type="radio"/> LE <input type="radio"/> GA <input type="radio"/> MT <input type="radio"/> PI <input type="radio"/> LA <input type="radio"/> BL <input type="radio"/> OR <input type="radio"/> BR <input type="radio"/> RE <input type="radio"/> VI <input type="radio"/> GS

* JTR-2610: For liquid nitrogen storage at -196°C



LABELS

**DEEP FREEZE
BARCODE LABELS**



NitroTAG™ Temperature range from -196°C to +100°C

Roll format labels for barcode thermal transfer printers. Plastic waterproof labels for long-term storage in cryogenic harsh laboratory environments and biorepositories. Resistant to liquid phase and vapor phase liquid nitrogen, dry ice and multiple freeze-thaw cycles. Coated with CryoMAX™ adhesive for extra-strong adhesion to polypropylene and other plastic surfaces as well as to a wide variety of materials.

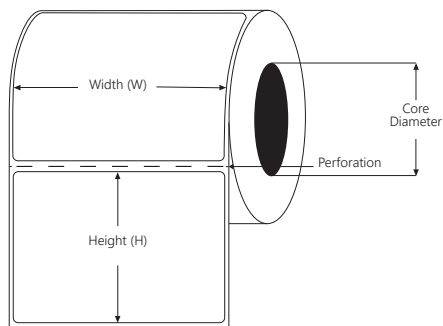

Must be used with
2R-class
Alcohol-Proof Ribbons
(See P.28)

RECTANGLES / ROLL FORMAT

Item #	mm (W x H)	Inches (W x H)	Core dia.	Labels/Roll	Cena/role
JTT-164C1-10WH	6.35 x 25.4	0.25" x 1"	25mm	10,000	4816
JTT-164C3-10WH	6.35 x 25.4	0.25" x 1"	76mm	10,000	4816
JTT-160C1-2WH	22.2 x 11.11	0.875" x 0.4375"	25mm	2,000	1792
JTT-160C3-6WH	22.2 x 11.11	0.875" x 0.4375"	76mm	6,000	4256
JTT-7SBC1-3WH	25.4 x 12.7	1" x 0.5"	25mm	3,000	2408
JTT-7SBC3-6WH	25.4 x 12.7	1" x 0.5"	76mm	6,000	4256
JTT-4C1-1WH	25.4 x 19.1	1" x 0.75"	25mm	1,000	1176
JTT-4C3-1WH	25.4 x 19.1	1" x 0.75"	75mm	1,000	1176
JTT-29C1-1WH	25.4 x 25.4	1" x 1"	25mm	1,000	1400
JTT-29C3-1WH	25.4 x 25.4	1" x 1"	75mm	1,000	1400
JTT-57C1-1WH	28.6 x 19	1.125" x 0.75"	25mm	1,000	1400
JTT-57C3-1WH	28.6 x 19	1.125" x 0.75"	76mm	1,000	1400
JTT-18C1-2WH	31.8 x 12.7	1.25" x 0.5"	25mm	2,000	1456
JTT-18C3-2WH	31.8 x 12.7	1.25" x 0.5"	76mm	2,000	1456
JTT-58C1-1WH	31.8 x 25.4	1.25" x 1"	25mm	1,000	1456
JTT-58C3-1WH	31.8 x 25.4	1.25" x 1"	76mm	1,000	1456
JTT-9C1-1WH	31.8 x 22.2	1.25" x 0.875"	25mm	1,000	1372
JTT-9C3-1WH	31.8 x 22.2	1.25" x 0.875"	75mm	1,000	1372
JTT-97C1-1WH	32.5 x 15.9	1.28" x 0.625"	25mm	1,000	1456
JTT-97C3-1WH	32.5 x 15.9	1.28" x 0.625"	76mm	1,000	1456
JTT-6C1-3WH	34.9 x 12.7	1.375" x 0.5"	25mm	3,000	2828
JTT-6C3-3WH	34.9 x 12.7	1.375" x 0.5"	76mm	3,000	2828
JTT-65C1-1WH	31.8 x 31.8	1.25" x 1.25"	25mm	1,000	1428
JTT-65C3-1WH	31.8 x 31.8	1.25" x 1.25"	76mm	1,000	1428
JTT-10C1-1WH	38.1 x 19.1	1.5" x 0.75"	25mm	1,000	1372
JTT-10C3-1WH	38.1 x 19.1	1.5" x 0.75"	76mm	1,000	1372
JTT-38C1-2WH	44.5 x 12.7	1.75" x 0.5"	25mm	2,000	2240
JTT-38C3-6WH	44.5 x 12.7	1.75" x 0.5"	76mm	6,000	5600
JTT-24C1-2WH	44.5 x 25.4	1.75" x 1"	25mm	2,000	2464
JTT-24C3-2WH	44.5 x 25.4	1.75" x 1"	76mm	2,000	2464
JTT-148C1-4WH	50.8 x 7	2" x 0.276"	25mm	4,000	2352
JTT-148C3-4WH	50.8 x 7	2" x 0.276"	76mm	4,000	2352



RECTANGLES / ROLL FORMAT

Item #	mm (W x H)	Inches (W x H)	Core dia.	Labels/Roll	Cena/Role
JTT-85C1-2WH	50.8 x 15.9	2" x 0.625"	25 mm	2,000	2240
JTT-85C3-2WH	50.8 x 15.9	2" x 0.625"	76 mm	2,000	2240
JTT-28C1-2WH	50.8 x 25.4	2" x 1"	25 mm	2,000	3136
JTT-28C3-2WH	50.8 x 25.4	2" x 1"	76 mm	2,000	3136
JTT-68C1-1WH	63.5 x 19.1	2.5" x 0.75"	25 mm	1,000	1680
JTT-68C3-1WH	63.5 x 19.1	2.5" x 0.75"	76 mm	1,000	1680
JTT-5C1-1WH	63.5 x 24.5	2.5" x 1"	25 mm	1,000	1680
JTT-5C3-1WH	63.5 x 24.5	2.5" x 1"	76 mm	1,000	1680



CIRCLES / ROLL FORMAT

Item #	mm (diameter)	Inches (diameter)	Core dia.	Labels/Roll	Cena/Role
JTT-59NOTC1-2WH	6.4 mm	0.25" Circle	25mm	2,000	2016
JTT-59NOTC3-2WH	6.4 mm	0.25" Circle	76 mm	2,000	2016
JTT-61NOTC1-4WH	9 mm	0.354" Circle	25 mm	4,000	3808
JTT-61NOTC3-4WH	9 mm	0.354" Circle	76 mm	4,000	3808
JTT-22NOTC1-2WH	11 mm	0.438" Circle	25 mm	2,000	2072
JTT-22NOTC3-2WH	11 mm	0.438" Circle	76 mm	2,000	2072
JTT-53NOTC1-2WH	12.7 mm	0.5" Circle	25 mm	2,000	2072
JTT-53NOTC3-2WH	12.7 mm	0.5" Circle	76 mm	2,000	2072
CTT-106C1-2WH	19 mm	0.75" Circle	25 mm	2,000	2184
CTT-106C3-2WH	19 mm	0.75" Circle	76 mm	2,000	2184
JTT-115C1-1WH	25.4 mm	1" Circle	25 mm	1,000	1400
JTT-115C3-1WH	25.4 mm	1" Circle	76 mm	1,000	1400
JTT-155C1-1WH	38 mm	1.5" Circle	25 mm	1,000	1820
JTT-155C3-1WH	38 mm	1.5" Circle	76 mm	1,000	1820
CTT-132C1-1WH	50.8 mm	2" Circle	25 mm	1,000	3024
CTT-132C3-1WH	50.8 mm	2" Circle	76 mm	1,000	3024
CTT-83C1-1WH	57.2 mm	2.25" Circle	25 mm	1,000	3220
CTT-83C3-1WH	57.2 mm	2.25" Circle	76 mm	1,000	3220
CTT-90C1-0.5WH	68 mm	2.677" Circle	25 mm	500	2100
CTT-90C3-1WH	68 mm	2.677" Circle	76 mm	1,000	3640
JTT-156C1-0.25WH	79.4 mm	3.125" Circle	25 mm	250	1428
JTT-156C3-0.25WH	79.4 mm	3.125" Circle	76 mm	250	1428



Veškeré informace na www.biologicals.cz a www.biologicals.cz/e-shop

LABELS

DEEP FREEZE
BARCODE LABELS



NitroTAG™

Temperature range from -196°C to +100°C



RECTANGLE + CIRCLE / ROLL FORMAT

Item #	mm (W x H)	Inches (W x H)	Label Sets Across	Core dia	Label Sets/Roll	Cena/Role
JTT-103C1-2WH	31.8 x 16 + 9.5	1.25" x 0.625" + 0.375"	1	25 mm	2,000	1680
JTT-103C3-2WH	31.8 x 16 + 9.5	1.25" x 0.625" + 0.375"	1	76 mm	2,000	1680
JTT-52NOTC1-2WH	23.9 x 12.7 + 11	0.94" x 0.5" + 0.437"	1	25 mm	2,000	2800
JTT-52NOTC3-4WH	23.9 x 12.7 + 11	0.94" x 0.5" + 0.437"	1	76 mm	4,000	5040
JTT-183C1-2WH	25.4 x 12.7 + 9.5	1" x 0.5" + 0.375"	1	25 mm	2,000	2800
JTT-183C3-4WH	25.4 x 12.7 + 9.5	1" x 0.5" + 0.375"	1	76 mm	4,000	5040
JTT-70C1-1WH	28.6 x 19 + 11	1.125" x 0.75" + 0.437"	1	25 mm	1,000	1680
JTT-70C3-2WH	28.6 x 19 + 11	1.125" x 0.75" + 0.437"	1	76 mm	2,000	2800
JTT-161C1-2WH	30.2 x 25.4 + 9.5	1.1875" x 1" + 0.375"	1	25 mm	2,000	2800
JTT-161C3-2WH	30.2 x 25.4 + 9.5	1.1875" x 1" + 0.375"	1	76 mm	2,000	2800
JTT-158-C1-2WH	31.8 x 12.7 + 11	1.25" x 0.5" + 0.437"	1	25 mm	2,000	2800
JTT-158-C3-2WH	31.8 x 12.7 + 11	1.25" x 0.5" + 0.437"	1	76 mm	2,000	2800
JTT-172C1-2WH	31.8 x 16 + 11	1.25" x 0.625" + 0.437"	1	25 mm	2,000	2800
JTT-172C3-2WH	31.8 x 16 + 11	1.25" x 0.625" + 0.437"	1	76 mm	2,000	2800



SPECIAL FORMS / ROLL FORMAT

Item #	mm (W x H)	Inches (W x H)	Core dia.	Labels/Roll	Cena/Role
JTT-150C1-1WH	30.8 mm x 6.92 mm 2x teeth	1.213" x 0.2724" 2x teeth	25 mm	1,000	1624
JTT-150C3-3WH	30.8 mm x 6.92 mm 2x teeth	1.213" x 0.2724" 2x teeth	76 mm	3,000	3752



JTT-150: Special design label for barcoding conical bottom microtubes (1.5 - 2.0 ml)

Další velikosti a speciální tvary k doptání na info@biologicals.cz



Must be used with
2R-class
Alcohol-Proof Ribbons
(See P.28)

LABELS

FOR FROZEN CONTAINERS

CryoSTUCK™ Temperature range from -196°C to +80°C

Cryogenic thermal transfer labels for identification of already frozen containers: vials, tubes, cryogenic boxes, freezer boxes and other containers for long-term cryogenic storage and biopreservation in liquid phase and vapor phase liquid nitrogen, dry ice and harsh laboratory environments. Labels can be printed with all major brands of thermal transfer printers. Not recommended for exposure to water, aqueous solutions, solvents and moisture.

ROLL FORMAT

Item #	mm (W x H)	Inches (W x H)	Core Dia.	Labels/Roll	Cena
FSL-152C1-1WH	23 x 19	0.9" x 0.75"	25mm	1,000	1501
FSL-152C3-5WH	23 x 19	0.9" x 0.75"	76mm	5,000	5264
FSL-52NOTC1-2WH	23.9 x 12.7 + 11.1circle	0.94" x 0.5" + 0.437" circle	25mm	2,000	3248
FSL-52NOTC3-5WH	23.9 x 12.7 + 11.1circle	0.94" x 0.5" + 0.437" circle	76mm	5,000	7280
FSL-7C1-1WH	25.4 x 12.7	1" x 0.5"	25mm	1,000	1540
FSL-7C3-5WH	25.4 x 12.7	1" x 0.5"	76mm	5,000	5460
FSL-183C1-2WH	25.4 x 12.7 + 9.5 circle	1" x 0.5" + 0.375" circle	25mm	2,000	2800
FSL-183C3-5WH	25.4 x 12.7 + 9.5 circle	1" x 0.5" + 0.375" circle	76mm	5,000	6160
FSL-29C1-1WH	25.4 x 25.4	1" x 1"	25mm	1,000	1736
FSL-29C3-4WH	25.4 x 25.4	1" x 1"	76mm	4,000	5264
FSL-165C1-1WH	25.4 x 44.45	1" x 1.75"	25mm	1,000	2100
FSL-165C3-3WH	25.4 x 44.45	1" x 1.75"	76mm	3,000	5180
FSL-124C1-1WH	29.9 x 7.11 + 9.4 circle	1.18" x 0.28" + 0.37" circle	25mm	1,000	2072
FSL-124C3-4WH	29.9 x 7.11 + 9.4 circle	1.18" x 0.28" + 0.37" circle	76mm	4,000	6608
FSL-19C1-1WH	33 x 15.9	1.3" x 0.625"	25mm	1,000	1815
FSL-19C3-5WH	33 x 15.9	1.3" x 0.625"	76mm	5,000	6832
FSL-168C1-2WH	35.56 x 12.7	1.4" x 0.5"	25mm	2,000	2576
FSL-168C3-5WH	35.56 x 12.7	1.4" x 0.5"	76mm	5,000	5600



LABELS

**XYLENE & SOLVENT
RESISTANT**



XyliTAG™ BARCODE LABELS

Labels and ink are resistant to Xylene, Toluene, Alcohols, Acetone, Dimethyl Sulfoxide (DMSO), Methyl Ethyl Ketone (MEK), Acrylonitrile (ACN) and other chemicals. Ideal for slide labels in cytology and histology labs.

Resistant to:

- XYLENE
- TOLUENE
- ALCOHOLS
- ACETONE
- DIMETHYL SULFOXIDE (DMSO)
- METHYL ETHYL KETONE (MEK)
- ACRYLONITRILE (ACN)



Must be used with
TC-class Ribbons
(See P.29)

ROLL FORMAT

Item #	mm (W x H)	Inches (W x H)	Labels Across	Core dia.	Qty/Roll	Cena/Role
HTT-130C1-2WH	19 x 19	0.75" x 0.75"	2	25 mm	2,000	2772
HTT-130C3-4WH	19 x 19	0.75" x 0.75"	2	76 mm	4,000	4984
HTT-69C1-1WH	19 x 19	0.75" x 0.75"	1	25 mm	1,000	1232
HTT-69C3-1WH	19 x 19	0.75" x 0.75"	1	76 mm	1,000	1232
HTT-117C1-3WH	22 x 15	0.866" x 0.59"	1	25 mm	3,000	2156
HTT-117C3-3WH	22 x 15	0.866" x 0.59"	1	76 mm	3,000	2156
HTT-133C3-20WH	22 x 19	0.866" x 0.75"	4	76 mm	20,000	7280
HTT-98C1-1WH	22 x 22	0.875" x 0.875"	1	25 mm	1,000	1232
HTT-98C3-1WH	22 x 22	0.875" x 0.875"	1	76 mm	1,000	1232
HTT-95C1-4WH	22 x 22	0.875" x 0.875"	4	25 mm	4,000	3248
HTT-95C3-4WH	22 x 22	0.875" x 0.875"	4	76 mm	4,000	3248
HTT-141C1-2WH	23 x 19	0.90" x 0.75"	2	25 mm	2,000	2184
HTT-141C3-2WH	23 x 19	0.90" x 0.75"	2	76 mm	2,000	2184
HTT-67C1-1WH	24 x 24	0.937" x 0.937"	1	25 mm	1,000	1232
HTT-67C3-1WH	24 x 24	0.937" x 0.937"	1	76 mm	1,000	1232
HTT-121C1-2WH	24 x 24	0.937" x 0.937"	2	25 mm	2,000	2184
HTT-121C3-2WH	24 x 24	0.937" x 0.937"	2	76 mm	2,000	2184
HTT-125C1-4WH	24 x 24	0.937" x 0.937"	4	25 mm	4,000	3248
HTT-125C3-8WH	24 x 24	0.937" x 0.937"	4	76 mm	8,000	5936
HTT-157C1-1WH	24.9 x 23.4	0.975" x 0.92"	1	25 mm	1,000	1372
HTT-157C3-1WH	24.9 x 23.4	0.975" x 0.92"	1	76 mm	1,000	1372
HTT-137C1-8WH	25.4 x 25.4	1" x 1"	4	25 mm	8,000	5936
HTT-137C3-8WH	25.4 x 25.4	1" x 1"	4	76 mm	8,000	5936
HTT-93C1-1WH	69.8 x 63.5	2.75" x 2.5"	1	25 mm	1,000	6720
HTT-93C3-1WH	69.8 x 63.5	2.75" x 2.5"	1	76 mm	1,000	6720



Veškeré informace na www.biologicals.cz a www.biologicals.cz/e-shop



XyliTUFF™ BARCODE LABELS

Designed for containers and microscope slides used in histological staining protocols involving sequential exposure to solvents, running water and histostaining. XyliTUFF™ labels are resistant to xylene, toluene, acetone, ethanol and other solvents and harsh chemicals.

ROLL FORMAT						
Item #	mm (W x H)	Inches (W x H)	Labels Across	Core dia.	Qty/Roll	Cena/Role
XST-69C1-2WH	19 x 19	0.75" x 0.75"	1	25 mm	2,000	1904
XST-69C3-5WH	19 x 19	0.75" x 0.75"	1	76 mm	5,000	3920
XST-117C1-3WH	22 x 15	0.866" x 0.59"	1	25 mm	3,000	2156
XST-117C3-6WH	22 x 15	0.866" x 0.59"	1	76 mm	6,000	3836
XST-98C1-2WH	22 x 22	0.875" x 0.875"	1	25 mm	2,000	1904
XST-98C3-5WH	22 x 22	0.875" x 0.875"	1	76 mm	5,000	3920
XST-67C1-1WH	24 x 24	0.937" x 0.937"	1	25 mm	2,000	2072
XST-67C3-5WH	24 x 24	0.937" x 0.937"	1	76 mm	5,000	4340
XST-157C1-1WH	24.9 x 23.4	0.975" x 0.92"	1	25 mm	2,000	2184
XTT-157C3-5WH	24.9 x 23.4	0.975" x 0.92"	1	76 mm	5,000	4620
XST-93C1-1WH	69.8 x 63.5	2.75" x 2.5"	1	25 mm	1,000	6720
XST-93C3-1WH	69.8 x 63.5	2.75" x 2.5"	1	76 mm	1,000	6720



Must be used with
TX-class Ribbons
(See P.29)

www.biologicals.cz a www.biologicals.cz/e-shop

LABELS

WRAP-AROUND BARCODE LABELS



WRAP-AROUND LABELS For cryo storage as low as -196°C

Wrap-around labels for secure identification of samples in cryogenic storage. Can withstand liquid phase and vapor phase liquid nitrogen, dry ice, multiple freeze-thaw cycles. The wrap-around transparent part securely laminates the printable part and protects against exposures to chemicals and solvents, as well as against physical damage. HBTT labels can withstand temperatures up to +100°C, WTT labels can withstand up to +150°C, autoclave and dry-heat sterilization.

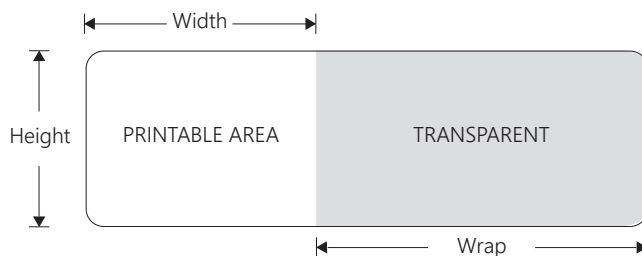

Item #	mm (W x H + Wrap)	Inches (W x H + Wrap)	Description	Core Diameter	Qty/Roll	Cena/Role
WTT-310BMC1-2WH	19.1 x 22 + 52 Wrap	0.75" x 0.875" + 2.07" Wrap	Black Mark, White	25 mm	2,000	4424
WTT-310BMC3-2WH	19.1 x 22 + 52 Wrap	0.75" x 0.875" + 2.07" Wrap	Black Mark, White	76 mm	2,000	4424
HBTT-314NOTC1-2WH	22.86 x 12.7 + 12.7 Wrap	0.9" x 0.5" + 0.5" Wrap	Notch, White	25 mm	2,000	2828
HBTT-314NOTC3-2WH	22.86 x 12.7 + 12.7 Wrap	0.9" x 0.5" + 0.5" Wrap	Notch, White	76 mm	2,000	2828
HBTT-313NOTC1-2WH	25.4 x 15.9 + 15.87 Wrap	1" x 0.625" + 0.625" Wrap	Notch, White	25 mm	2,000	2912
HBTT-313NOTC3-2WH	25.4 x 15.9 + 15.87 Wrap	1" x 0.625" + 0.625" Wrap	Notch, White	76 mm	2,000	2912
WTT-304BMC1-2WH	25.4 x 15.9 + 35 Wrap	1" x 0.625" + 1.375" Wrap	Black Mark, White	25 mm	2,000	4424
WTT-304BMC3-2WH	25.4 x 15.9 + 35 Wrap	1" x 0.625" + 1.375" Wrap	Black Mark, White	76 mm	2,000	4424
WTT-311BMC1-2WH	25.4 x 15.9 + 25.4 Wrap	1" x 0.625" + 1" Wrap	Black Mark, White	25 mm	2,000	3220
WTT-311BMC3-2WH	25.4 x 15.9 + 25.4 Wrap	1" x 0.625" + 1" Wrap	Black Mark, White	76 mm	2,000	3220
HBTT-317NOTC1-1WH	25.4 x 25.4 + 43.7 Wrap	1" x 1" + 1.72" Wrap	Notch, White	25 mm	1,000	2408
HBTT-317NOTC3-1WH	25.4 x 25.4 + 43.7 Wrap	1" x 1" + 1.72" Wrap	Notch, White	76 mm	1,000	2408
WTT-309NOTC1-1WH	25.4 x 30 + 43 Wrap	1" x 1.18" + 1.69" Wrap	Black Mark, White	25 mm	1,000	2408
WTT-309NOTC3-1WH	25.4 x 30 + 43 Wrap	1" x 1.18" + 1.69" Wrap	Black Mark, White	76 mm	1,000	2408
WTT-303NOTC1-1WH	28.6 x 25.4 + 41 Wrap	1.125" x 1" + 1.63" Wrap	Notch, White	25 mm	1,000	2744
WTT-303NOTC3-1WH	28.6 x 25.4 + 41 Wrap	1.125" x 1" + 1.63" Wrap	Notch, White	76 mm	1,000	2744
HBTT-308NOTC1-1WH	34 x 25.4 + 35 Wrap	1.34" x 1" + 1.38" Wrap	Notch, White	25 mm	1,000	2352
HBTT-308NOTC3-1WH	34 x 25.4 + 35 Wrap	1.34" x 1" + 1.38" Wrap	Notch, White	76 mm	1,000	2352



Must be used with
WR-class ribbons
(See P.28)

Další velikosti a barvy na vyžádání
info@biologicals.cz



LABELS

CRYOGENIC STRAW-TAG

StrawTAG™ Temperature range from -196°C to +80°C

The white part of the label can be printed with regular thermal transfer barcode printers. Labels can withstand long-term cryogenic storage at -196°C in liquid and vapor phase liquid nitrogen and ultra-low temperature freezers.

Item #	mm (W x H)	Inches (W x H)	Recommended for	Core Diameter	Qty/Roll	Cena/Role
CST-29-NOT0.25C1-1	25.4 x 25.4	1" x 1"	0.25 ml IVF Straw	25 mm	1,000	1736
CST-29-NOT0.5C1-1	25.4 x 25.4	1" x 1"	0.5 ml IVF Straw	25 mm	1,000	1736
CST-79-NOT0.25C1-1	35 x 22	1.375" x 0.875"	0.25 ml IVF Straw	25 mm	1,000	2156
CST-79-NOT0.5C1-1	35 x 22	1.375" x 0.875"	0.5 ml IVF Straw	25 mm	1,000	2156
CST-28-NOT0.25C1-1	50.8 x 25.4	2" x 1"	0.25 ml IVF Straw	25 mm	1,000	2856
CST-28-NOT0.5C1-1	50.8 x 25.4	2" x 1"	0.5 ml IVF Straw	25 mm	1,000	2856

Cryogenic straw labels of other dimensions can be provided. All Cryo Straw-Tag™ labels are also available on 76 mm cores.

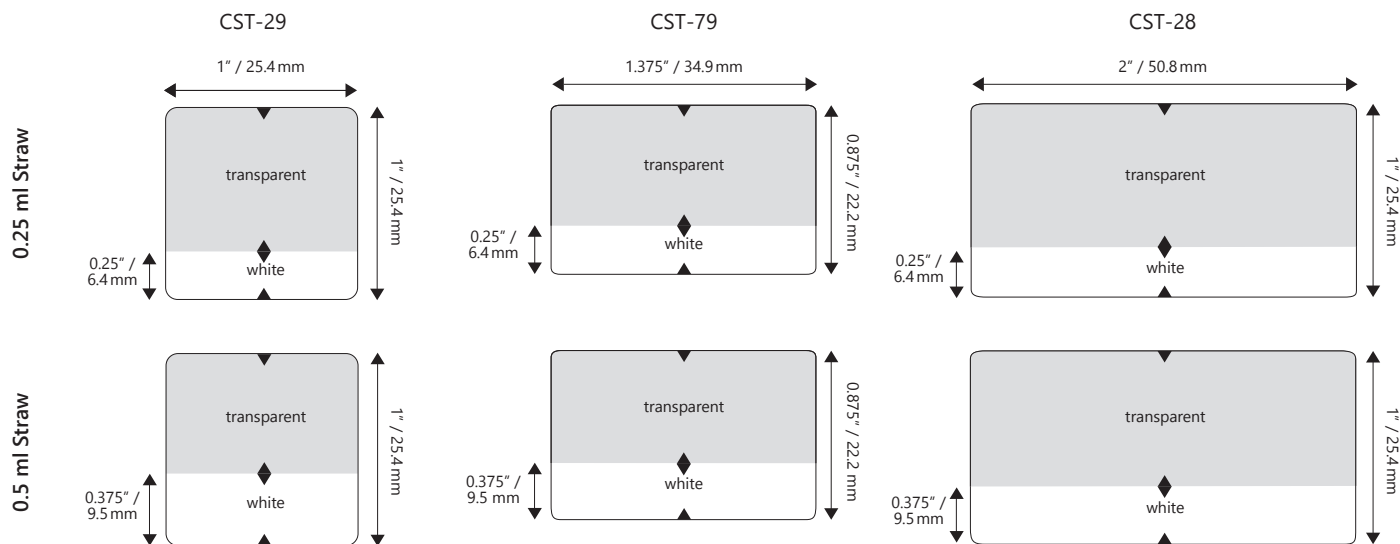

Cryogenic Straw Identification System

Item #	Printer	Ribbon	Scanner	Straw Labels	Software License	Interface	Cena
SYS-31-10	Thermal Transfer Printer 300DPI	TT Ribbon	-	1,000	1 User Unlimited Printers	USB, Cable	na dotázání
SYS-31-11	Thermal Transfer Printer 300DPI	TT Ribbon	LS2208	1,000	1 User Unlimited Printers	USB, Cable	na dotázání



Další velikosti a barvy k doptání na info@biologicals.cz

LABELS

**FOR CRYOGENIC
METAL RACKS**



MetalITAG™ Temperature range from -196°C to +100°C

Cryogenic thermal transfer labels for the identification of metal racks. Designed for long-term storage and biopreservation in liquid phase and vapor phase liquid nitrogen and freezers. Labels can be printed with all major brands of thermal transfer printers. Glove-friendly.

ROLL FORMAT

Item #	mm (W x H)	Inches (W x H)	Labels Across	Core	Qty/Roll	Cena/Role
RM TT-4C1-2WH	25.4 x 19.1	1" x 0.75"	1	25 mm	2,000	2184
RM TT-4C3-5WH	25.4 x 19.1	1" x 0.75"	1	76 mm	5,000	4620
RM TT-19C1-1WH	33 x 15.9	1.3" x 0.625"	1	25 mm	1,000	1456
RM TT-19C3-1WH	33 x 15.9	1.3" x 0.625"	1	76 mm	1,000	1456
RM TT-48C1-1WH	38.1 x 63.5	1.5" x 2.5"	1	25 mm	1,000	2380
RM TT-48C3-1WH	38.1 x 63.5	1.5" x 2.5"	1	76 mm	1,000	2380
RM TT-24C1-2WH	44.5 x 25.4	1.75" x 1"	1	25 mm	2,000	2744
RM TT-24C3-2WH	44.5 x 25.4	1.75" x 1"	1	76 mm	2,000	2744
RM TT-28C1-1WH	50.8 x 25.4	2" x 1"	1	25 mm	1,000	1792
RM TT-28C3-1WH	50.8 x 25.4	2" x 1"	1	76 mm	1,000	1792
RM TT-147C1-4WH	67 x 7	2.64" x 0.276"	1	25 mm	4,000	2772
RM TT-147C3-4WH	67 x 7	2.64" x 0.276"	1	76 mm	4,000	2772
RM TT-36C1-1WH	76 x 25.4	3" x 1"	1	25 mm	1,000	1736
RM TT-36C3-1WH	76 x 25.4	3" x 1"	1	76 mm	1,000	1736
RM TT-122C1-0.3WH	102 x 102	4" x 4"	1	25 mm	300	2156
RM TT-122C3-0.5WH	102 x 102	4" x 4"	1	76 mm	500	3220



Must be used with
**resin or wax-resin
ribbons**
(See P.28)



“The world’s largest selection of cryogenic labels”

LABELS

CALIBRATION LABELS/
ANIMAL CAGE LABELS

CALIBRATION LABELS

CalTAG™ Self-Laminating Calibration Removable Labels

Item #	mm (W x H)	Inches (W x H)	Description	Perforation	Adhesive	Qty/Roll	Cena/Role
CAL-001-R	19 x 38	0.75" x 1.5"	Calibration Label	Yes	Removable	1,000	1904
CAL-002-R	25.4 x 54	1" x 2.125"	Calibration Label	Yes	Removable	1,000	2576

Step 1: Fill in the information

Transparent flap
with support liner

Fill in the information

Step 2: Remove the support liner
from the transparent flap

Remove the
support liner

Step 3: Press down the transparent
flap to laminate the label

Press down
and laminate

Other dimensions of calibration labels with removable or permanent adhesives are available.

ANIMAL CAGE LABELS

GlueFree-Tags™ are adhesive-free water-proof static cling labels for identification of animal cages. Can be inscribed with permanent marker and ball-point pen. Thermal-transfer printable. Available in multiple colors.

Easy to use - just apply to cage (glass or plastic) and press. Available blank or pre-printed.

Item #	mm (W x H)	Inches (W x H)	Description	Qty/Roll	Cena CZK	<input type="radio"/> WH <input type="radio"/> YE <input type="radio"/> GA <input type="radio"/> BL <input type="radio"/> OR <input type="radio"/> PI <input type="radio"/> RE
GFT-1BM	54 x 35	2.125" x 1.375"	Static Label	500	1260	<input type="radio"/> <input type="radio"/> <input type="radio"/> <input type="radio"/> <input type="radio"/> <input type="radio"/> <input type="radio"/>



LABELS

WARNING LABELS



WARNING LABELS

Plastic labels for cryogenic and deep-freeze applications, can withstand multiple freeze-thaw cycles, boiling water, dry ice, UV rays, Gamma irradiation and other deep-freeze and harsh lab environments. The printout is protected against water, alcohol and other chemicals and solvents. Water resistant, wear and tear proof.

FOR DEEP-FREEZE USE

Temperature range from -196°C to +100°C

Item #	mm (W x H)	Inches (W x H)	Description	Lamination	Qty/Roll	Cena/Role
LTR-13-BIO	13	0.5"	Biohazard Symbol	Yes	1,000	1288
WL-003-1000	29 x 29	1.125" x 1.125"	Biohazard Symbol	Yes	1,000	2492
WL-006-100	50.8 x 50.8	2" x 2"	Biohazard Symbol	Yes	100	1820
LTR-13-RADBK	13	0.5"	Radioactive Symbol (Black)	Yes	1,000	1288
LTR-13-RADMG	13	0.5"	Radioactive Symbol (Magenta)	Yes	1,000	1288
WL-001-250	45 x 19	1.75" x 0.75"	"Toxic" text	Yes	250	980
WL-002-250	45 x 19	1.75" x 0.75"	Non-Hazardous	Yes	250	980
WL-004-1000	29 x 29	1.125" x 1.125"	NFPA (Blank)	Yes	1,000	2492
WL-005-1000PR	29 x 29	1.125" x 1.125"	NFPA (Printed)	Yes	1,000	2632



LTR-13-BIO



LTR-13-RAD



WL-001



WL-002



WL-003 & WL-006



WL-004 & WL-005

FOR GENERAL USE

Item #	mm (W x H)	Inches (W x H)	Description	Adhesive	Qty/Roll	Cena/Role
L-001-R	25.4 x 38	1" x 1.5"	Cytotoxic	Removable	1,000	1176
L-002-R	50.8 x 50.8	2" x 2"	Cytotoxic	Removable	1,000	1288
L-003-R	101.6 x 101.6	4" x 4"	Cytotoxic	Removable	1,000	1708
L-004-R	69 x 25.4	2.72" x 1"	Radioactive	Removable	1,000	1456
L-004-P	69 x 25.4	2.72" x 1"	Radioactive	Permanent	1,000	1372
L-005-P	33.3 x 228.6	1.312" x 9"	Incineration	Permanent	500	2744
L-006-R	76.2 x 101.6	3" x 4"	SIMDUT	Removable	500	1736



L-002



L-004



L-005



L-006

Custom made warning labels for general use or deep-freeze applications can be provided according to your specifications

Biologicals s.r.o. Objednávajte na orders@biologicals.cz a www.biologicals.cz/e-shop; Tel: +420-274776731; FAX: +420-274773997; Mobil: +420-608315488



LABELS

TAMPER-PROOF LABELS

TAMPER-PROOF LABELS

Can be printed with thermal-transfer printers or inscribed with permanent markers. The labels will self destroy upon attempt to remove. Ideal for using on plastic bags, plates, vials, CD cases and other containers where tamper-proof seal is required.



ROLL FORMAT

Item #	mm (W x H)	Inches (W x H)	Core Diameter	Qty/Roll	Cena CZK
CTD-7C1-1	25.4 x 12.7	1" x 0.5"	25 mm	1,000	2184
CTD-7C3-1	25.4 x 12.7	1" x 0.5"	76 mm	1,000	2184
CTD-28C1-1	50.8 x 25.4	2" x 1"	25 mm	1,000	3332
CTD-28C3-1	50.8 x 25.4	2" x 1"	76 mm	1,000	3332

TAMPER-EVIDENT CRYOGENIC LABELS *Temperature range from -196°C to +100°C*

Plastic waterproof labels. The Labels will tear into pieces upon attempt to remove. Ideal for cryogenic vials and containers when tamper-evidence is required in cryogenic and deep-freeze harsh laboratory environments and biorepositories. Can withstand long-term storage in liquid phase and vapor phase liquid nitrogen, -80°C freezers, dry ice and multiple freeze-thaw cycles.



ROLL FORMAT

Item #	mm (W x H)	Inches (W x H)	Core Diameter	Qty/Roll	Cena CZK
TEJ-1C1-1WH	19 x 46	0.75" x 1.8125"	25 mm	1,000	2240
TEJ-1C3-3WH	19 x 46	0.75" x 1.8125"	76 mm	3,000	5600

Další informace na www.biologicals.cz a [~/e-shop](#)

DYMO

LABELS

DIRECT THERMAL



CRYO DTERMO™

Cryogenic DTermo™ direct thermal labels - DYMO compatible. For ultra-low temperature applications (as low as -196°C). Resist to liquid phase and vapor phase liquid nitrogen, -80°C freezers, dry ice and multiple freeze-thaw cycles.



FOR DEEP-FREEZE USE

Item #	mm (W x H)	Inches (W x H)	Qty/Roll	Cena/Role	<input type="radio"/> WH <input type="radio"/> YE <input type="radio"/> BL <input type="radio"/> RE <input type="radio"/> GA <input type="radio"/> OR <input type="radio"/> PI <input type="radio"/> GR <input type="radio"/> BE <input type="radio"/> LE <input type="radio"/> VI <input type="radio"/> BR
CD1F-030	9 mm circle	0.35" circle	2,000	2212	<input type="radio"/>
CF1F-030	9 mm circle	0.35" circle	2,000	2632	<input type="radio"/> YE <input type="radio"/> BL <input type="radio"/> RE <input type="radio"/> GA <input type="radio"/> OR
CD1F-050	13 mm circle	0.5" circle	2,000	2212	<input type="radio"/>
CF1F-050	13 mm circle	0.5" circle	2,000	2632	<input type="radio"/> YE <input type="radio"/> BL <input type="radio"/> RE <input type="radio"/> GA <input type="radio"/> OR
CD1F-040	13 x 25	0.5" x 1"	1,000	1372	<input type="radio"/>
CF1F-040	13 x 25	0.5" x 1"	1,000	1568	<input type="radio"/> BL <input type="radio"/> RE <input type="radio"/> GA
CD1F-060	14 x 87	0.56" x 3.44"	350	1400	<input type="radio"/>
CD1F-073	18 x 38	0.7" x 1.49"	500	1297	<input type="radio"/>
CF1F-073	18 x 38	0.7" x 1.49"	500	1484	<input type="radio"/> RE
CD1F-071	20 x 45	0.79" x 1.77"	500	1299	<input type="radio"/>
CD1F-070	25.4 x 25.4	1" x 1"	750	1652	<input type="radio"/>
CD1F-010	25.4 x 54	1" x 2.125"	500	1372	<input type="radio"/>
CF1F-010	25.4 x 54	1" x 2.125"	500	1568	<input type="radio"/> YE <input type="radio"/> BL <input type="radio"/> RE <input type="radio"/> GA <input type="radio"/> OR <input type="radio"/> PI
CD1F-072	26 x 12.7 + 9.5	1.04" x 0.5" + 0.375"	500	2016	<input type="radio"/>
CF1F-072	26 x 12.7 + 9.5	1.04" x 0.5" + 0.375"	500	2380	<input type="radio"/> RE <input type="radio"/> GR <input type="radio"/> BE <input type="radio"/> LE <input type="radio"/> VI <input type="radio"/> BR
CD1F-020	29 x 89	1.125" x 3.5"	350	1400	<input type="radio"/>
CF1F-020	29 x 89	1.125" x 3.5"	350	1610	<input type="radio"/> YE <input type="radio"/> BL <input type="radio"/> RE <input type="radio"/> GA <input type="radio"/> OR

DTERMO™ REGULAR

DTermo™ paper labels for regular use (non-cryogenic). DYMO compatible.



FOR GENERAL USE

Item #	mm (W x H)	Inches (W x H)	Qty/Roll	Cena/Role	<input type="radio"/> WH <input type="radio"/> YE <input type="radio"/> BL <input type="radio"/> RE <input type="radio"/> GA <input type="radio"/> OR <input type="radio"/> PI <input type="radio"/> GR <input type="radio"/> BE <input type="radio"/> LE <input type="radio"/> VI <input type="radio"/> BR
DY-030	9 mm circle	0.35" Circle	3,000	1061	<input type="radio"/> YE <input type="radio"/> BL <input type="radio"/> RE <input type="radio"/> GA <input type="radio"/> OR
DY-050	13 mm circle	0.5" Circle	3,000	1061	<input type="radio"/> YE <input type="radio"/> BL <input type="radio"/> RE <input type="radio"/> GA <input type="radio"/> OR
DY-040	13 x 25	0.5" x 1"	1,000	977	<input type="radio"/> BL <input type="radio"/> RE <input type="radio"/> GA
DY-060	14 x 87	0.56" x 3.44"	350	840	<input type="radio"/>
DY-010	26 x 54	1" x 2.125"	500	1092	<input type="radio"/> YE <input type="radio"/> BL <input type="radio"/> RE <input type="radio"/> GA <input type="radio"/> OR
DY-072	26 x 12.7 + 9.5	1.04" x 0.5" + 0.375"	500	1092	<input type="radio"/> RE <input type="radio"/> GR <input type="radio"/> BE <input type="radio"/> LE <input type="radio"/> VI <input type="radio"/> BR
DY-020	29 x 89	1.125" x 3.5"	350	896	<input type="radio"/> YE <input type="radio"/> BL <input type="radio"/> RE <input type="radio"/> GA <input type="radio"/> OR

LAB SUPPLIES

TUBES & Cryo-BOXES

MICROCENTRIFUGE TUBES

These graduated tubes facilitate accurate sampling. The polypropylene (PP) tubes are resistant to most chemical reagents and can be autoclaved at 130°C. The microcentrifuge tubes come with attached snap cap. Available as 0.5ml, 0.6ml and 1.5ml tubes.

Item #	Description	Top	Bottom	Qty	Cena	Color Selection
111558C	1.5 ml tube	Flat	Conical	10,000	8200	Natural
111550	0.6 ml tube	Flat	Conical	5,000	6863	Natural
110550	0.5 ml tube	Flat	Conical	5,000	7512	Natural



CRYOGENIC TUBES

These cryogenic tubes are 95kPa compliant and are lot-certified to be free of human DNA, DNase, RNase, pyrogens and ATP. All tubes are manufactured in accordance with the FDA and quality guidelines ISO 13485:2004 and ISO 14644 (Federal Standard 209) in a Class 7 clean room (Class 10,000). They comprise a patent-pending screw cap produced from a special grade of polyethylene (PE) and molded with a thermoplastic elastomer (TPE). When tightening the screw cap to the tube, the TPE expands and functions as an o-ring, providing a 100% leak-free. Each tube is printed with a barcode for sample tracking. Separate cap inserts are available for color coding.

Sterile, external threads, graduated, printed writing space and barcode, Temp. -196°C to 121°C, autoclavable at 121°C.

Item #	Volume	Top	Bottom	Qty/PK	Cena
3010	1 ml tube	Flat	Self-standing	500 (10x50)	5038
3012	2 ml tube	Flat	Self-standing	500 (10x50)	5038
3013	3 ml tube	Flat	Self-standing	500 (10x50)	5715
3014	4 ml tube	Flat	Self-standing	500 (10x50)	5771
3015	5 ml tube	Flat	Self-standing	500 (10x50)	6160

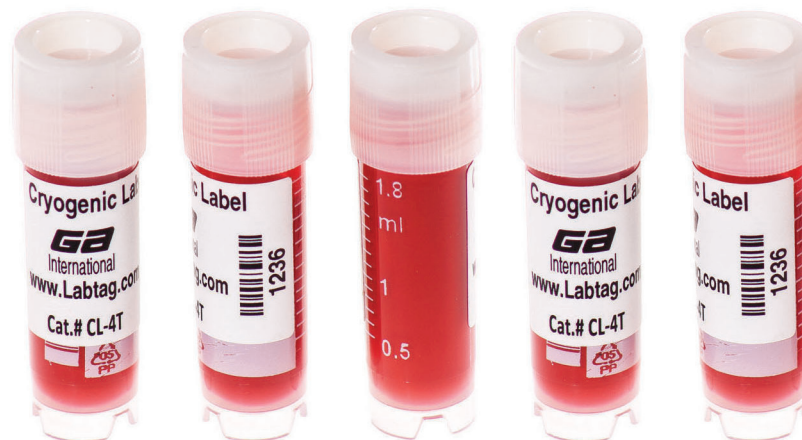
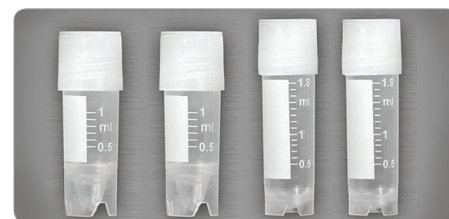

Doporučeno pro štítky a popisovače LabTAG

TAPES

-196°C

CRYO-TAPE™ *Temperature range from -196°C to +100°C*

Continuous tape for cryogenic use. Water-proof, resistant to liquid phase and vapor phase liquid nitrogen, dry ice, multiple freeze-thaw cycles, gamma irradiation and other harsh laboratory environments. Extra Strong CryoMax™ adhesive.

Item #	Metric	Inches x Feet	Cena CZK	WH	YE	GA	BL	OR	RE
TJT-13C1-50	13 mm x 15 m	0.5" x 50'	1176	○	●	●	●	●	●
TJT-19C1-50	19 mm x 15 m	0.75" x 50'	1204	○	●	●	●	●	●
TJT-25C1-50	25.4 mm x 15 m	1" x 50'	1260	○	●	●	●	●	●



CryoSTUCK™ FOR FROZEN CONTAINERS *Temperature range from -196°C to +100°C*

Cryogenic tape for the identification of already frozen vials, tubes, freezer boxes, plastic bags and other containers. Designed for long-term biopreservation in:

- Liquid phase and vapor phase liquid nitrogen
- Ultra-low temperature freezers

Tapes can be printed with all major brands of thermal-transfer printers. Not recommended for exposure to water, aqueous solutions, solvents and moisture.

Item #	Metric	Inches	Cena CZK	WH	YE	GA	BL	OR	RE	
TFS-13C1-50	13 mm x 15 m	0.5" x 50'	1260	○	●	●	●	●	●	
TFT-13C1-50	13 mm x 15 m	0.5" x 50'	1260	Transparent						
TFS-19C1-50	19 mm x 15 m	0.75" x 50'	1288	○	●	●	●	●	●	
TFT-19C1-50	19 mm x 15 m	0.75" x 50'	1288	Transparent						
TFS-25C1-50	25.4 mm x 15 m	1" x 50'	1344	○	●	●	●	●	●	
TFT-25C1-50	25.4 mm x 15 m	1" x 50'	1344	Transparent						



TAMPER-EVIDENT CRYO-TAPE™ *Temperature range from -196°C to +100°C*

Continuous tamper-evident tape for sealing containers and other items. Will tear into pieces upon attempt to remove from most surfaces. Capable of withstanding cryogenic storage environments. For freezer and liquid nitrogen use. Water-proof.

Item #	Metric	Inches x Feet	Price
TET-22C1-50	22.23 mm x 15 m	0.875" x 50'	1288

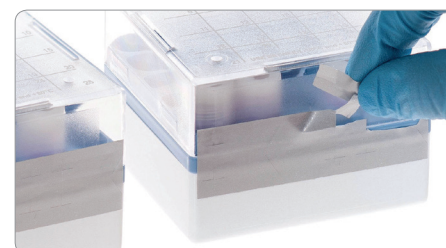



-196°C

CRYO-LAMINATE™ Temperature range from -196°C to +100°C

This ultra-thin laminate provides excellent protection against most chemicals and reagents. Can be used for long-term storage in liquid phase and vapor phase liquid nitrogen and ultra-low temperature freezers. Resistant to dry ice, boiling water, multiple freeze-thaw cycles and other harsh laboratory environments.

Item #	Metric	Inches x Feet	Cena CZK
CLAM-19C3-200	19 mm x 60 m	0.75" x 200'	1260
CLAM-25C3-200	25 mm x 60 m	1" x 200'	1456
CLAM-50C3-200	50.8 mm x 60 m	2" x 200'	1666



CRYO-TAPE™ FOR METAL RACKS Temperature range from -196°C to +100°C

Cryogenic tape for identification of various cryogenic containers for long-term cryo storage. Can be used for identification of stainless steel and aluminium metal racks, X-ray cassettes and film cans for storage in liquid nitrogen and ultra-low temperature freezers. Glove-friendly. Resistant to liquid nitrogen, dry ice, multiple freeze-thaw cycles, gamma irradiation and other harsh laboratory environments.

Item #	Metric	Inches x Feet	Cena CZK	WH	YE	GA	BL	OR	RE
TRM-13C1-50	13 mm x 15 m	0.5" x 50'	1115	<input type="radio"/>	<input type="radio"/>	<input type="radio"/>	<input type="radio"/>	<input type="radio"/>	<input type="radio"/>
TRM-19C1-50	19 mm x 15 m	0.75" x 50'	1204	<input type="radio"/>	<input type="radio"/>	<input type="radio"/>	<input type="radio"/>	<input type="radio"/>	<input type="radio"/>
TRM-25C1-50	25.4 mm x 15 m	1" x 50'	1313	<input type="radio"/>	<input type="radio"/>	<input type="radio"/>	<input type="radio"/>	<input type="radio"/>	<input type="radio"/>



COLOR LAB-TAPE™

FOR GENERAL LABORATORY USE.

Available colors: White, grey, yellow, green apple, pink, light blue, orange, red, purple, green seafoam

Item #	Metric	Inches	Cena CZK	WH	YE	BL	RE	GA	PI	GR	OR	PU	GS
PAT-13	13 mm x 55 m	0.5" x 180'	812	<input type="radio"/>	<input type="radio"/>	<input type="radio"/>	<input type="radio"/>	<input type="radio"/>	<input type="radio"/>	<input type="radio"/>	<input type="radio"/>	<input type="radio"/>	<input type="radio"/>
PAT-18	18 mm x 55 m	0.71" x 180'	821	<input type="radio"/>	<input type="radio"/>	<input type="radio"/>	<input type="radio"/>	<input type="radio"/>	<input type="radio"/>	<input type="radio"/>	<input type="radio"/>	<input type="radio"/>	<input type="radio"/>
PAT-24	24 mm x 55 m	0.94" x 180'	863	<input type="radio"/>	<input type="radio"/>	<input type="radio"/>	<input type="radio"/>	<input type="radio"/>	<input type="radio"/>	<input type="radio"/>	<input type="radio"/>	<input type="radio"/>	<input type="radio"/>



CRYO MARKERS



HCL-1
HCL-2

ALCOHOL-RESISTANT SCIENCE-MARKER™



- Cryogenic permanent marker
- Alcohol-resistant
- Water resistant
- Fine tip
- Jednotlivé popisovače pouze s jinou položkou katalogu
- Při samostatném odběru, nejmenší množství 10 ks

Item #	Color	Cena
SM-1B	Black	122
SM-1G	Green	122

DUAL POINT CRYO-MARKER™



- Water-proof cryogenic permanent marker
- High quality dual point
- Extra fine and fine points (2 pens in 1)
- Durable, heavy duty long lasting nibs (withstand rough treatment and provide delicate touch on various materials)
- Excellent performance on plastic, glass, metal, cloth, teflon and other surfaces
- Low odor
- Jednotlivé popisovače pouze s jinou položkou katalogu
- Při samostatném odběru, nejmenší množství 10 ks

Item #	Color	Cena
MP-1B	Black	129
MP-1BL	Blue	129
MP-1R	Red	129
MP-1G	Green	129
MP-1PL	Purple	129
MP-1O	Orange	129
MP-1BR	Brown	129
MP-1YE	Yellow	129

MICRO-TIP CRYO-MARKER™



- Cryogenic waterproof permanent marker
- Water proof
- High quality permanent ink micro-tip marker
- Ultra-Fine line 0.25 mm.
- Hard plastic tips are protected by metal sleeves and will not split, so lines are clean and precise every time.
- Excellent performance in areas where detailed writing is required, such as marking on small micro-centrifuge and PCR tubes, labels, beakers, glass plates, X-ray and photographic films.

Item #	Color	Cena
F-1B	BLACK	168
F-1BL	BLUE	168
F-1R	RED	168

BIG-TIP CRYO-WAXI™ MARKER



- Solid Ink
- Opaque
- Fade and Water proof permanent marker
- Big Tip
- Marks on most surfaces
- Jednotlivé popisovače pouze s jinou položkou katalogu
- Při samostatném odběru, nejmenší množství 5 ks

Item #	Color	Cena
CW-1FOR	Fluo Orange	287
CW-1FYE	Fluo Yellow	287
CW-1FPI	Fluo Pink	287
CW-1BL	Blue	287
CW-1R	Red	287
CW-1G	Green	287
CW-1PL	Purple	287
CW-1O	Orange	287
CW-1B	Black	287
CW-1YE	Yellow	287

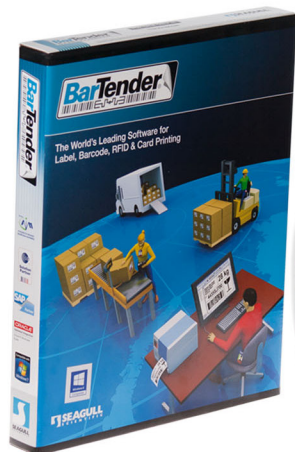

PRINT SOLUTIONS

PRINTING KITS

Ready to use barcode label printing systems

Item#	Printer	Ribbon	Labels	Interface	Software	Cena
PKT-T-31	Zebra GX430T, 300 dpi Thermal Transfer Printer	Smudge-Proof Resin Ribbon 244'	Roll of 5,000 cryogenic labels	USB Ethernet	Professional Version Software 1 User, Unlimited Printers	Na dotázání
PKT-T-33	Zebra GX430t, 300 dpi Thermal Transfer Printer Internal Ethernet connection	Smudge-Proof Resin Ribbon 244'	Roll of 5,000 cryogenic labels	USB, Serial, Parallel	Professional Version Software 1 User, Unlimited Printers	Na dotázání
PKT-T-33-N	Zebra GX430t, 300 dpi Thermal Transfer Printer Internal Ethernet connection	Smudge-Proof Resin Ribbon 244'	Roll of 5,000 cryogenic labels	USB, Serial, Parallel	Automation Version Software Unlimited Users, 3 Printers	Na dotázání
PKT-Z4-31	Zebra ZM400, 300 dpi Thermal Transfer Printer	Smudge-Proof Resin Ribbon	Roll of 5,000 cryogenic labels	USB, Serial, Parallel	Professional Version Software 1 User, Unlimited Printers	Na dotázání
PKT-Z4-61	Zebra ZM400, 600 dpi Thermal Transfer Printer	Smudge-Proof Resin Ribbon	Roll of 5,000 cryogenic labels	USB, Serial, Parallel	Professional Version Software 1 User, Unlimited Printers	Na dotázání

"Technical support by professional scientists"

PRINT SOLUTIONS



PRINTERS

These printers are well-suited to a lab environment and can be provided with options according to specifications. Printers of other brands, models and configurations are available. *Prices Upon Request*

Item #	Description
GX430T	<ul style="list-style-type: none"> • Thermal Transfer Printer • 300 dpi • 4-Inches-Per-Second Print Speed • Serial, Parallel and USB Interfaces
S4M	<ul style="list-style-type: none"> • Thermal Transfer Printer • 300 dpi • 4-Inch-Wide Labeling • Serial, Parallel and USB Interfaces
ZM400	<ul style="list-style-type: none"> • Thermal Transfer Printer • Available in 300 & 600 dpi • Serial, Parallel and USB Interfaces • 4-Inch-Wide Labeling • 10-Inches-Per-Second Print Speed



GX430T



S4M

MORE PRINTING KITS AVAILABLE ON
info@biologicals.cz

SOFTWARE

FOR BARCODE PRINTERS

Item #	Number of Users	Maximum Printers	Cena	High performance label printing software for roll and fanfold formats
TP-1	1	Unlimited	Na dotázání	<ul style="list-style-type: none"> • Advanced Text Formatting • RFID Capabilities (optional) • Designer Typefaces • Exceptional Design Flexibility • "Instant" Barcodes • Enhanced database Connectivity • Password Security • On-Screen Display • Import and Export Graphics • Customizing Labels • Compliance Labels • Customized Serialization • Custom Data-Entry Forms • Industrial Symbols • Predefined "Toolbox" Components • Customizing Features • Free Tech. Support.
GATE-3	Unlimited	3	Na dotázání	

FOR LASER & INKJET PRINTERS

Item #	Number of Users	Cena	High performance label printing software for sheet & roll formats
GA-LM81	1	Na dotaz	<ul style="list-style-type: none"> • Simplified RFID Label Printing • Advanced text Capabilities • Enhanced Database Connectivity • Time Saving Features • Graphical tag images can be used to appear as a watermark on labels to protect against printing over and damaging RFID tags. • Enabled read / write printers to read the data during printing to log the exact information stored on each label • Supports High Frequency (HF) and Ultra Frequency (UHF) tags. • Free Tech. Support
GA-LM83	3	Na dotaz	



SCANNERS



PSCAN-1BK



LS2208-WH-USB



DS6707-WH-USB



LS4278-WH-USB



GA-DS3478-SFKIT

BARCODE SCANNERS

Item #	Description	Available colors	Cena
PSCAN-1BK	1-Dimensional POSX USB Scanner Kit with Cable	Black	Na dotázání
LS2208-WH-USB	Motorola scanner USB Series A Kit with cable - Multiples interfaces	Black or White	Na dotázání
DS6707-WH-USB	2-Dimensional Barcode Scanner USB Series A Straight Cable 7' Kit	Black or White	Na dotázání
LS4278-WH-USB	Wireless 1-Dimensional Barcode Scanner USB Series A Kit with Cable	Black or White	Na dotázání
GA-DS3478-SFKIT	Wireless 2-Dimensional Barcode Scanner Imager	Yellow	Na dotázání

“No minimum order requirements”

PRINT SOLUTIONS

RIBBONS



Standard Use

For **ZEBRA G-class, TLP class and similar printers**

Item #	Type	Metric	Inches	Cena
RR57X74C0.5-1ZZ2	Resin	57 mm x 74 m	2.24" x 244'	1070
WR57X74C0.5-1ZZ2	Wax-Resin	57 mm x 74 m	2.24" x 244'	984
WR64X74C0.5-1iZ4	Wax-Resin	64 mm x 74 m	2.5" x 244'	893
RR64X74C0.5-1iZ4	Resin	64 mm x 74 m	2.5" x 244'	1031
RR84X74C0.5-1iZ4	Resin	84 mm x 74 m	3.3" x 244'	1344
WR84X74C0.5-1ZZ4	Wax-Resin	84 mm x 74 m	3.3" x 244'	1050
WR110X74C0.5-1ZZ4	Wax-Resin	110 mm x 74 m	4.3" x 244'	1207
RR110X74C0.5-1iZ4	Resin	110 mm x 74 m	4.3" x 244'	1580
WR110X91C0.5-1iZ4	Wax-Resin	110 mm x 91 m	4.3" x 298'	1356

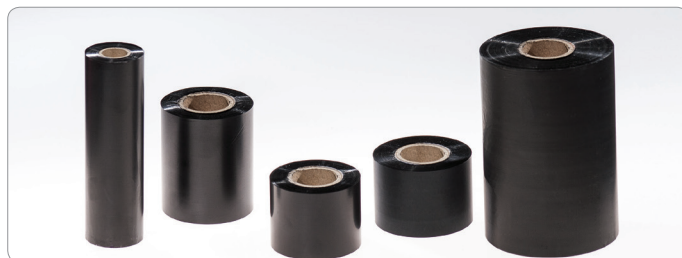

For **ZEBRA Z, XI & SL Classes, CITIZEN CL-S631 and similar printers.**

Item #	Type	Metric	Inches	Cena
RR25X450C1-1iZ4	Resin	25 mm x 450 m	0.98" x 1476'	1528
RR40X300C1-1iZ4	Resin	40 mm x 300 m	1.57" x 984'	1536
WR40X300C1-1iZ4	Wax-Resin	40 mm x 300 m	1.57" x 984'	1397
RR40X450C1-1iZ4	Resin	40 mm x 450 m	1.57" x 1476'	1932
WR40X450C1-1iZ4	Wax-Resin	40 mm x 450 m	1.57" x 1476'	1815
RR60X300C1-1iZ4	Resin	60 mm x 300 m	2.36" x 984'	2050
RR60X450C1-1iZ4	Resin	60 mm x 450 m	2.36" x 1476'	2795
WR60X450C1-1iZ4	Wax-Resin	60 mm x 450 m	2.36" x 1476'	2442
WR80X450C1-1iZ4	Wax-Resin	80 mm x 450 m	3.2" x 1476'	1294
RR83X450C1-1ZZ4	Resin	83 mm x 450 m	3.27" x 1476'	2991
RR89X300C1-1iZ4	Resin	89 mm x 300 m	3.5" x 984'	2338
RR89X450C1-1ZZ4	Resin	89 mm x 450 m	3.5" x 1476'	3226
WR89X450C1-1ZZ4	Wax-Resin	89 mm x 450 m	3.5" x 1476'	2967
RR110X300C1-1iZ4	Resin	110 mm x 300 m	4.3" x 984'	2755
RR110X450C1-1ZZ4	Resin	110 mm x 450 m	4.3" x 1476'	3853
WR110X450C1-1iZ4	Wax-Resin	110 mm x 450 m	4.3" x 1476'	3383

Alcohol-Proof

For **ZEBRA G-class, TLP Class and similar printers**

Item #	Type	Metric	Inches	Cena
2R64X74C0.5-1TZ4	Resin	64 mm x 74 m	2.5" x 244'	1223
2R84X74C0.5-1TZ4	Resin	84 mm x 74 m	3.3" x 244'	1454
2R110X74C0.5-1TZ4	Resin	110 mm x 74 m	4.33" x 244'	1693

For **ZEBRA Z, XI & SL Classes, CITIZEN CL-S631 and similar printers.**

Item #	Type	Metric	Inches	Cena
2R40X450C1-1TZ4	Resin	40 mm x 450 m	1.57" x 1476'	2461
2R64X300C1-1TZ4	Resin	64 mm x 300 m	2.52" x 984'	2610
2R80X300C1-1TZ4	Resin	80 mm x 300 m	3.2" x 984'	3163
2R102X300C1-1TZ4	Resin	102 mm x 300 m	4.02" x 984'	3829



Xylene & Solvent Resistant

For ZEBRA G-class, TLP class and similar printers

Item #	Type	Metric	Inches	Cena
TC55X74C0.5-1RZ4	Resin	55 mm x 74 m	2.17" x 244'	1250
TC60X74C0.5-1RZ4	Resin	60 mm x 74 m	2.36" x 244'	1311
TC89X74C0.5-1RZ4	Resin	89 mm x 74 m	3.5" x 244'	1673
TC107X74C0.5-1RZ4	Resin	107 mm x 74 m	4.2" x 244'	1893

For ZEBRA Z, XI & SL Classes, CITIZEN CL-S631 and similar printers.

Item #	Type	Metric	Inches	Cena
TC25X354C1-1RZ4	Resin	25 mm x 354 m	1" x 1181'	3265
TC34X450C1-1RZ4	Resin	34 mm x 450 m	1.33" x 1476'	3265
TC60X450C1-1RZ4	Resin	60 mm x 450 m	2.36" x 1476'	3579
TC89X450C1-1RZ4	Resin	89 mm x 450 m	3.5" x 1476'	5147
TC104X150C1-1RZ4	Resin	104 mm x 150 m	4.1" x 500'	2795
TC107X450C1-1RZ4	Resin	107 mm x 450 m	4.2" x 1476'	6244



Must be used with **HTT-class** labels (See P. 12)

Harsh Chemical, Xylene & Solvent Resistant

For ZEBRA G-class, TLP class and similar printers.

Item #	Type	Metric	Inches	Cena
TX55X74C0.5-1JZ4	Resin	55 mm x 74 m	2.17" x 244'	1319
TX64X74C0.5-1JZ4	Resin	64 mm x 74 m	2.5" x 244'	1435
TX84X74C0.5-1JZ4	Resin	84 mm x 74 m	3.3" x 244'	1017
TX110X74C0.5-1JZ4	Resin	107 mm x 74 m	4.33" x 244'	2069

For ZEBRA Z, XI & SL Classes, CITIZEN CL-S631 and similar printers.

Item #	Type	Metric	Inches	Cena
TX33X450C1-1JZ4	Resin	33 mm x 450 m	1.3" x 1476'	3536
TX40X300C1-1JZ4	Resin	40 mm x 300 m	1.57" x 984'	1536
TX60X300C1-1JZ4	Resin	60 mm x 300 m	2.36" x 984'	2767
TX89X300C1-1JZ4	Resin	89 mm x 300 m	3.5" x 984'	3924
TX110X300C1-1JZ4	Resin	110 mm x 300 m	4.33" x 984'	4721



Must be used with **XST or HTT-class** labels (See P. 12-13)

CUSTOM LABELS



CUSTOM MANUFACTURING

LabTAG is equipped with cutting-edge technologies to design and manufacture labels of any dimension, shape, color and configuration in sheet, roll and fanfold formats. LabTAG's capabilities include die cutting, lamination, varnish, print back and front, print on adhesive side, piggy-back labels and other techniques. LabTAG uses flexographic, digital, laser and thermal printing methods and its experienced production team is on stand-by to produce custom-made labels on short notice. LabTAG competitive pricing and short lead-times are unmatched in the industry.

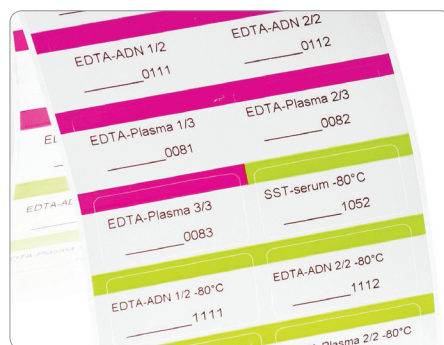

Custom printing for clinical trials

For years LabTAG has developed the expertise for making complex templates and printing variable data for clinical trials. LabTAG technical support team will assist you every step of the way including the selection of the correct materials, label template design, actual printing and packaging. LabTAG ensures the timely delivery of orders to almost any location worldwide. The support team of expert scientists can readily assist you in creating labels that follow standardized labeling guidelines such as ISBT 128, OSHA, ISBER and others.

**Podrobné informace získáte na dotázání na adrese
info@biologicals.cz**

Ceny v katalogu jsou uvedeny v CZK bez DPH

CRYO-STUCK™

Labels for frozen containers



Details on P.11



Navštivte náš e-shop

<http://www.biologicals.cz/e-shop>

nebo objednávejte dle katalogu přímo na

orders@biologicals.cz

Všechny ceny jsou vedeny bez DPH

Biologicals s.r.o.

Šrámkova 315
Ríčany
251 01
Czech Republic

IČ: 27575837
DIČ: CZ27575837

Kontakt

www.biologicals.cz
www.biologicals.cz/e-shop
info@biologicals.cz

Tel. +420-274776731
Fax. +420-274773997
Mob. +420-608315488